

Urządzenia do chodzenia po dachu klasy 1 według EN 516 nie mogą być stosowane jako punkty mocowania ochronnego wyposażenia osobistego, zabezpieczającego przed upadkiem.

Zařízení pro chůzi po střeše třídy 1 dle EN 516 se nesmí používat jako upevňovací body pro osobní ochranné vybavení zabezpečující před pádem.

Die begehbaren Dacheinrichtungen eingestuft in Klasse 1 nach EN516 dürfen nicht als Befestigung für persönliche Schutzausrüstung benutzt werden.

Dispositivos para moverse por la cubierta Clase 1 según EN 516 no se pueden utilizar como herramientas personales de punto de sujeción de protección que aseguren contra una caída

Les appareils pour marcher sur le toit de la Classe 1 selon EN 516 ne peuvent pas être utilisés comme l'équipement de protection individuelle pour assurer une protection contre les chutes.

Devices for walking on the roof of Class 1 according to EN 516 must not be used as attachment points for personal protective equipment, fall protection.

Az EN516 szabvány szerinti I. osztályba sorolt tetőközlekedők (pl. tetőjárdák) nem alkalmazhatók a magassági munkákhoz használatos személyi biztonsági felszerelések rögzítő pontjaként.

Gli accessori in classe 1 secondo EN 516 non possono essere utilizzati come punti di fissaggio per svolgere lavori sul tetto

Producten voor het lopen op het dak met klasse 1 volgens EN 516 mogen niet worden gebruikt als bevestigingspunten voor persoonlijke bescherming, valbeveiliging.

Dispositivo para andar no telhado classe 1 conforme EN 516 não pode ser utilizado como pontos de fixação de equipamentos de proteção pessoal ou proteção contra quedas

CZ Výrobce a Prodejce nenesí žádnou odpovědnost za nedodržení příslušných předpisů zákona, stavebních předpisů a bezpečnostních požadavků plus uživatelé výrobku, architekti, montéři nebo majitelé objektu.

D Hersteller und Verkäufer übernehmen keine Haftung für Nichtbeachtung entsprechender Rechts- und Bauvorschriften sowie Sicherheitsanforderungen seitens Produktbenutzers, Architekten, Monteurs oder Gebäudebesitzers.

E El fabricante y el vendedor no tienen ninguna responsabilidad por el incumplimiento de la ley vigente, normas de construcción y exigencias de seguridad por parte del usuario del producto, arquitecto, instalador o el propietario del edificio.

FR Le fabricant et le revendeur ne prend aucune responsabilité de ne pas respecter les lois applicables, les règlements sur les bâtiments et les exigences de sécurité par l'utilisateur du produit, l'architecte, l'installateur ou le propriétaire du bâtiment.

GB Manufacturer and Seller shall bear no liability for failure to comply with the applicable laws, building codes and safety requirements by the user of the product, architect, fitter or owner of the building.

H A Gyártó és a Forgalmazó nem vállal semmiféle felelősséget a vonatkozó törvényi, építési és biztonsági előírások, termékekhasználati, építési, beszállókat vagy építésszállókat által be nem tartásáért.

I Il Produttore e il Rivenditore non potranno essere ritenuti responsabili per il mancato rispetto, da parte dell'utente del prodotto, del progettista, dell'installatore o del proprietario dell'edificio, delle leggi vigenti, nonché dei regolamenti edilizi e di quelli relativi alla sicurezza.

PL Producent i Sprzedawca nie ponosi żadnej odpowiedzialności za nieprzestrzeganie stosownych przepisów prawa, przepisów budowlanych i wymogów bezpieczeństwa przez użytkownika produktu, architekta, montażystę lub właściciela budynku.

RU Ниc производителя, ни дистрибутора ни тoй vor асума ниоун fel de răspundere pentru nerespectarea legilor în vigoare, a legilor din domeniul construcțiilor sau a măsurilor de siguranță impuse utilizatorilor produsului, arhitecților, montajștilor sau proprietarilor clădirii.

RUS В случае несоблюдения строительных, монтажных или эксплуатационных требований строительных правил и норм безопасности ответственность с производителя и продавца снимается.

SK Výrobca a predajca nenesú žiadnu zodpovednosť za nedodržanie príslušných ustanovení zákona, stavebných predpisov a bezpečnostných požiadaviek užívateľom výrobku, architektom, montérom alebo majiteľom objektu.

EN516/Klasa 1



FAKRO®  
RSB

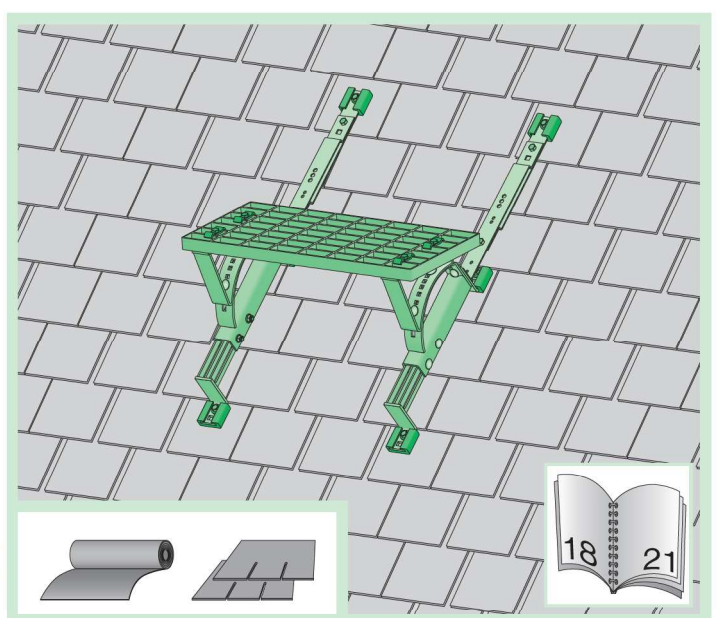
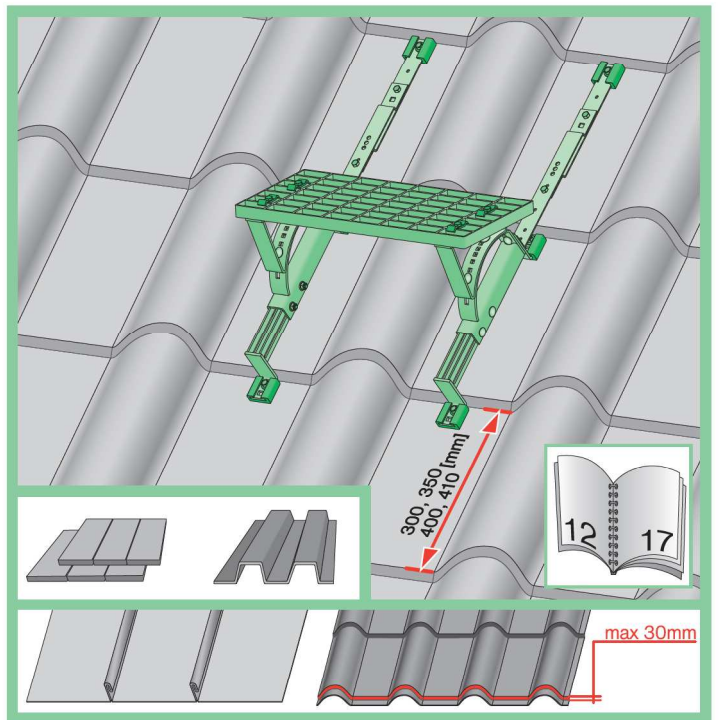
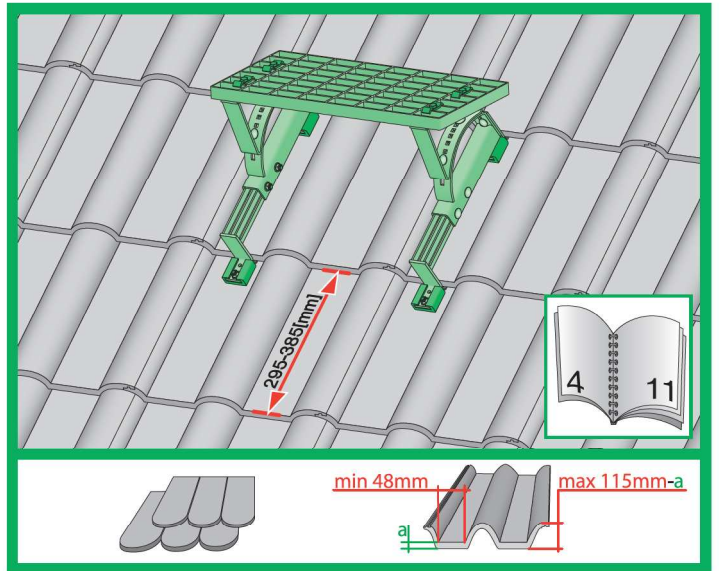

NC 97A

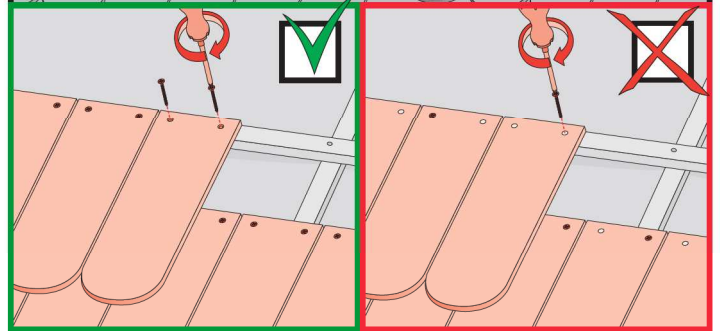
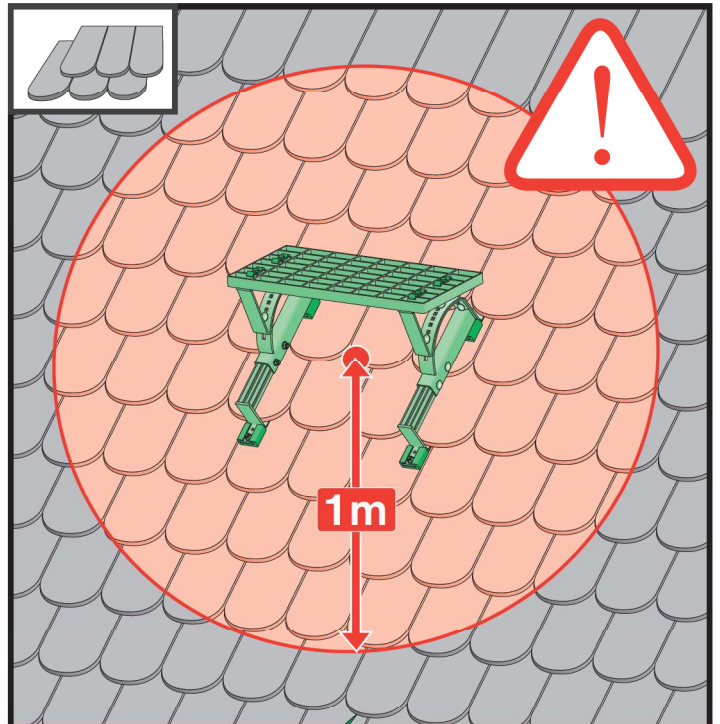
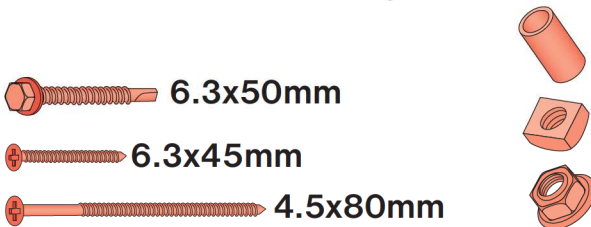
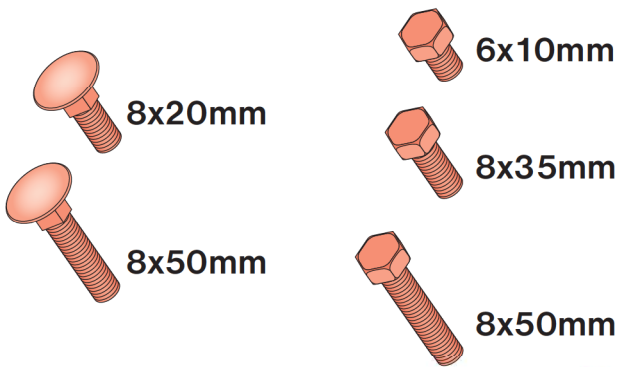
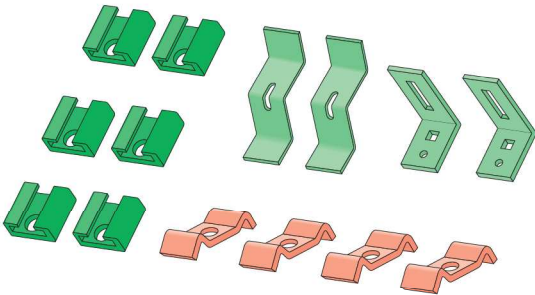
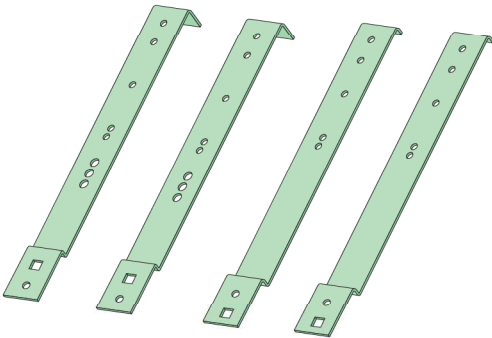
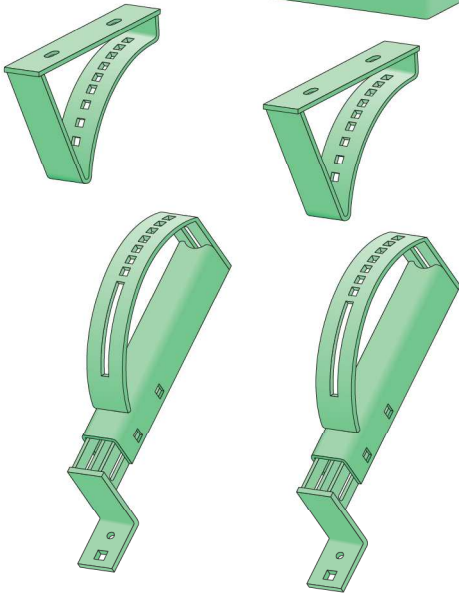
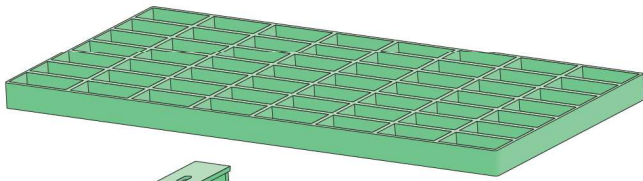

---



---



---



---



---



---



---



---

<b>CE</b>	FAKRO Sp. z o.o. ul. Węgierska 144a 33-300 Nowy Sącz Polska (Poland/Polen)	Rok wprowadzenia (Year of issue) (Einführungsjahr) 11
	PN-EN 516:2007	
<p>Stopnie szerokie klasy 1 przeznaczone do chodzenia po dachach pochylonych budynków (o nazwie handlowej „ława kominiarska RSB 45 i RSB 100”) (Wide steps class 1 are designed for walking on sloping roofs of buildings (trade name “RSB 45 chimney bench and RSB 100 chimney bench”) (Breite Trittstufen der Klasse 1 zum Betreten des Daches (Handelsbezeichnung „Laufrost RSB 45 und RSB 100”)</p>		
	<b>RSB 45</b>	<b>RSB 100</b>
Wytrzymałość mechaniczna (Mechanical strength) (Mechanische Beständigkeit)	Klasa 1 (Class 1) (Klasse 1)	Klasa 1 (Class 1) (Klasse 1)
Reakcja na ogień (Reaction to fire) (Brandverhalten)	A1	A1
Odporność na działanie ognia zewnętrznego (External fire performance) (Schutz gegen Brand von außen)	Broof	Broof
Deklaracja zgodności WE (EC Declaration of conformity) (EU - Konformitätserklärung)	E200/516/11 z 18.11.2011	

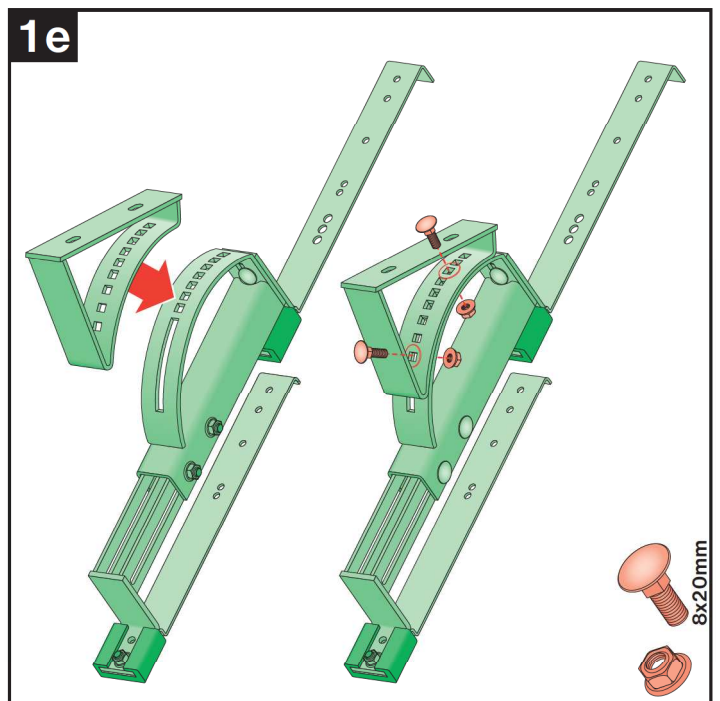
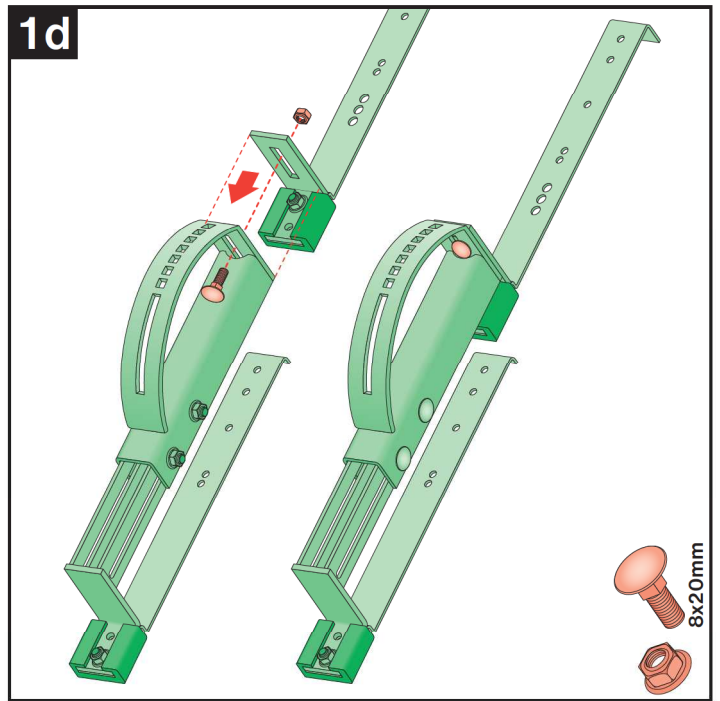
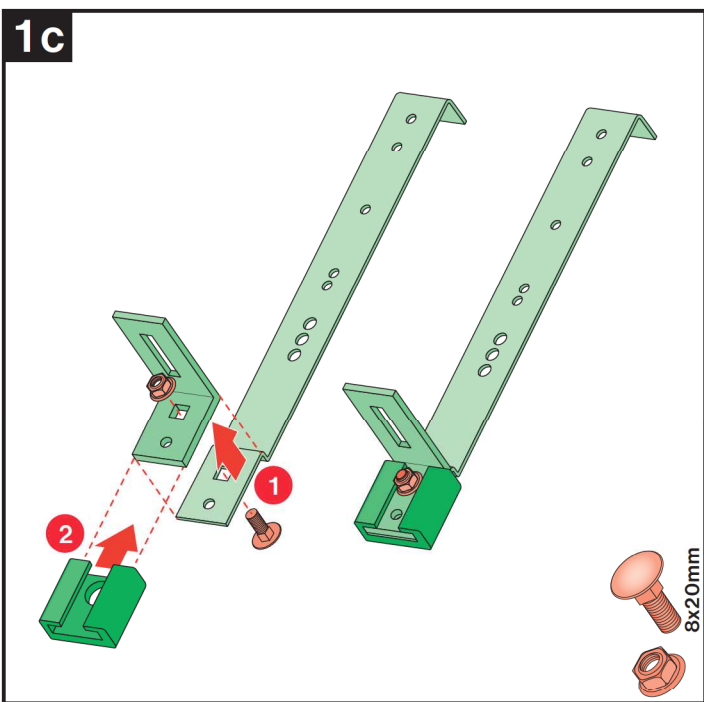
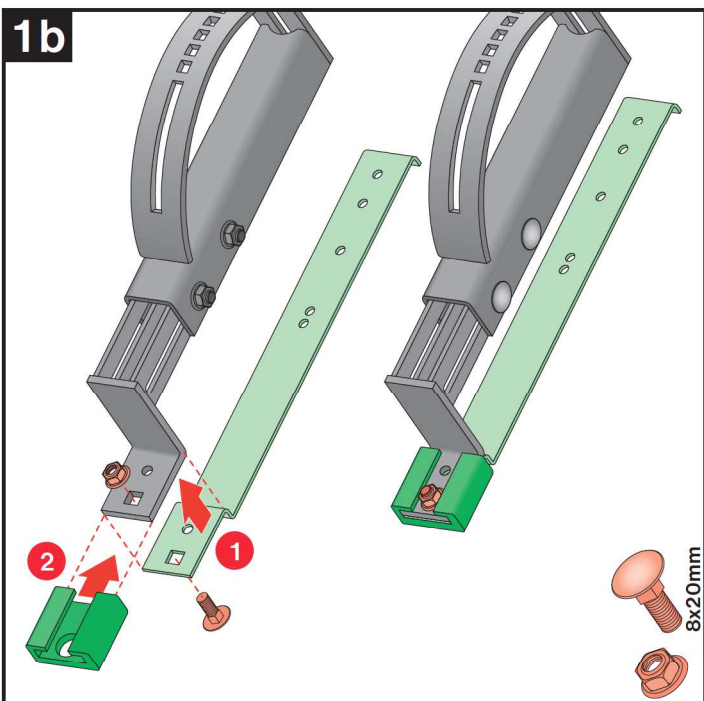
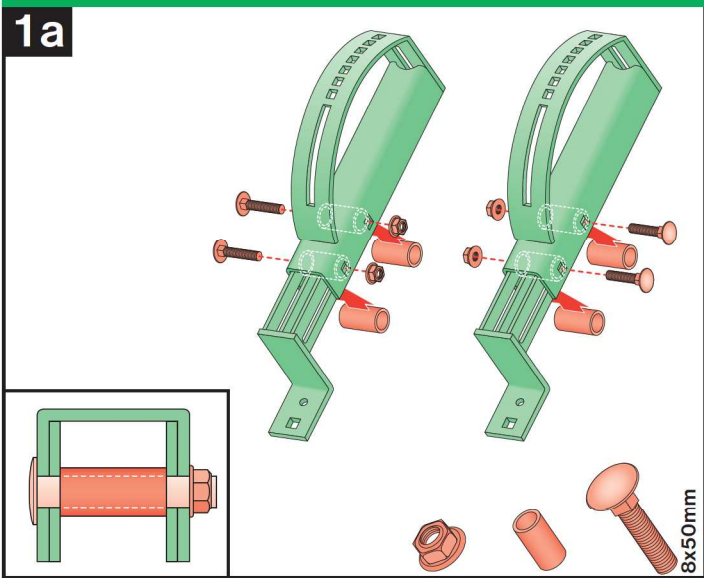

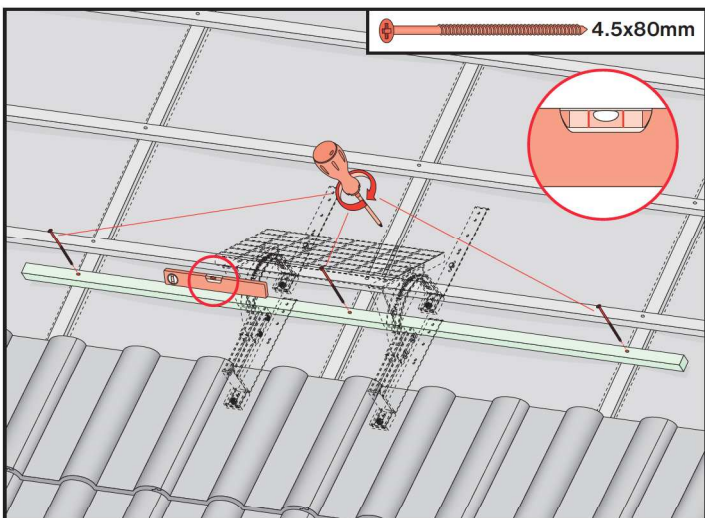
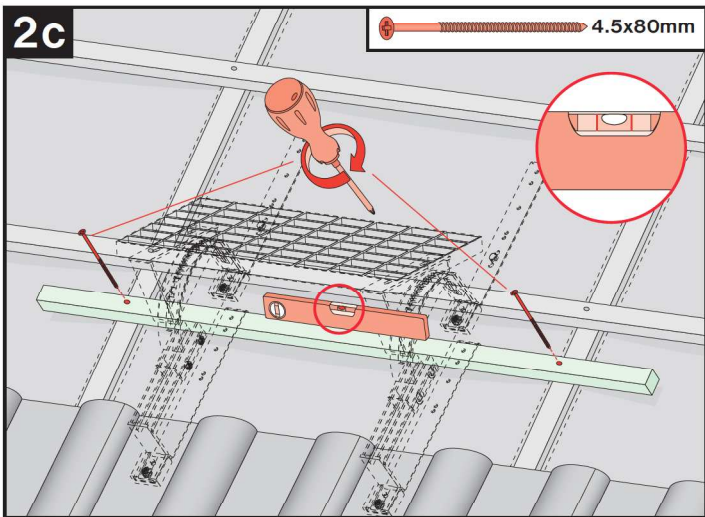
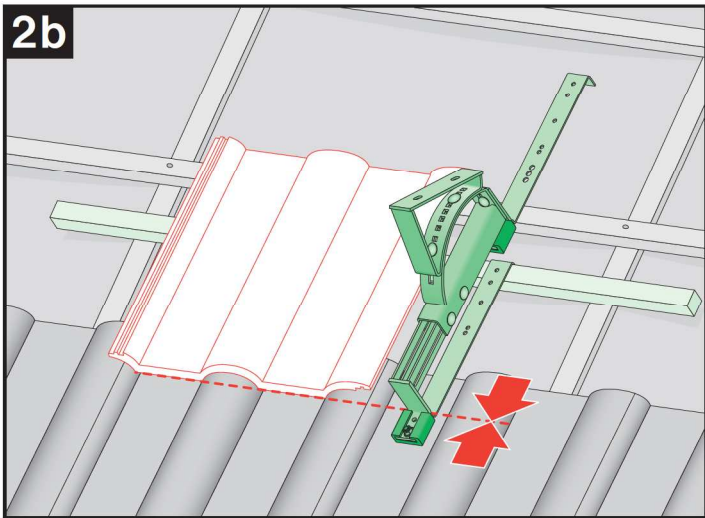
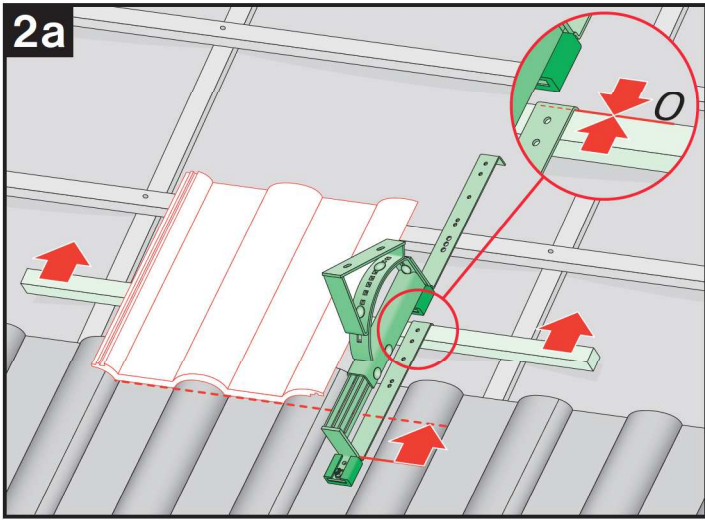

6

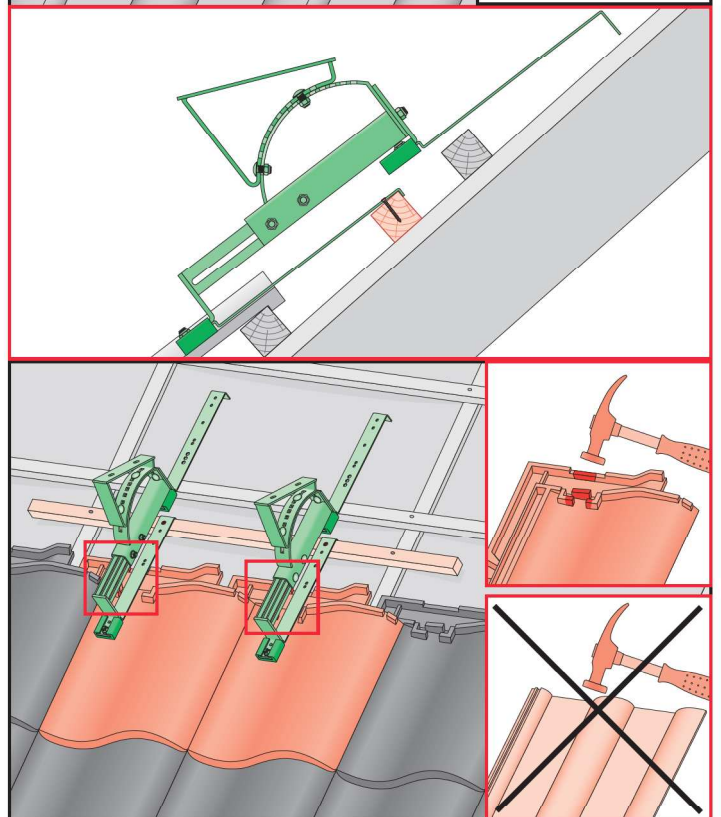
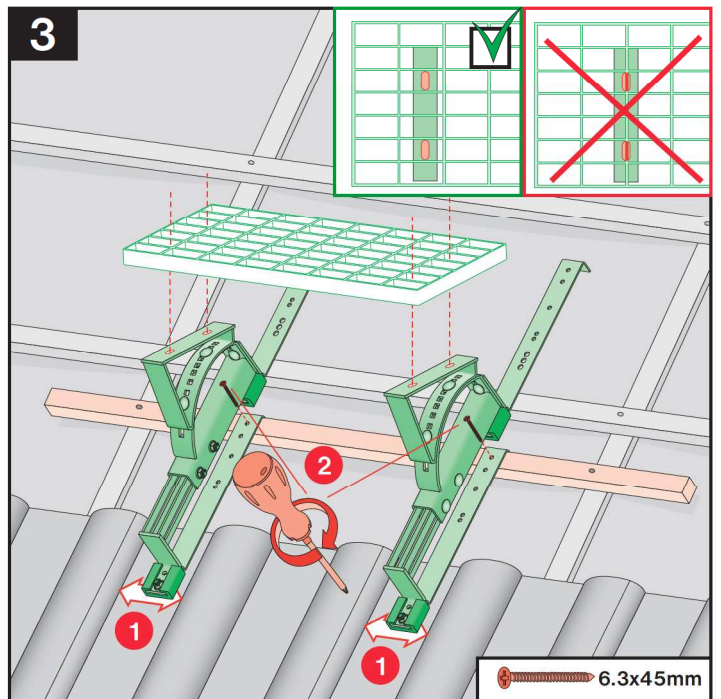
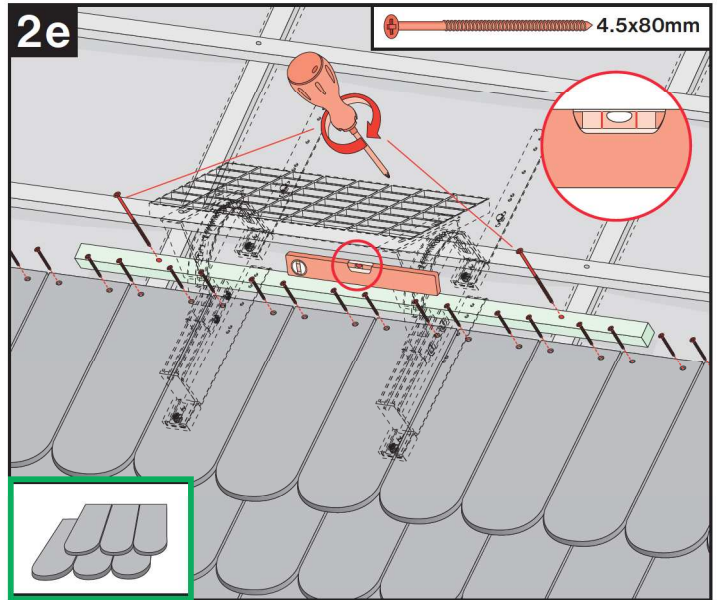

7

